

السليطين
للحدائق



Al Sulaiteen Gardens

THINK - PLAN - PERFORM - MAINTAIN

COMPANY
Profile



www.alsulaiteengardens.com

COP - 01



*Professional
Service!*

*Nature
Friendly*



OUR COMPANY & TEAM	3
COMPANY BACKGROUND / ENVIRONMENTAL AWARENESS	5
OUR SERVICES	7
SOFT AND HARDSCAPE DESIGN	9
IRRIGATION DESIGN	11
LANDSCAPE CONSTRUCTION: SOFT AND HARDSCAPE	13 - 19
CAR PARKING CONSTRUCTION	21
FOOTBALL FIELDS CONSTRUCTION	23
IRRIGATION CONSTRUCTION	25
SOFTSCAPE MAINTENANCE	27 - 31
IRRIGATION MAINTENANCE	33
SUPPLY & INSTALLATION:	
BARBECUE CRILL	35 - 37
UPVC PERGOLAS	39 - 43
UPVC ARBORS	45 - 47
ARTIFICIAL WESTWOOD ARBOR	48 - 51
KIDS PLAY EQUIPMENT	53 - 55
RUBBER FLOORING	57
ROOF GARDEN	59
UPVC FENCING SYSTEM	61 - 65
ARTIFICIAL GREEN WALL	67 - 71
NATURAL GREEN WALL	73
ARTIFICIAL GRASS	75 - 77
COMBERS & SWEEPERS	78 - 79
ARTIFICIAL PLANTS	81 - 93
GRP PLANTER POTS	95 - 105
WPC TILES	107 - 109
GRASS FENCE	111
PEBBLE STONES	113
GRANITE & SLATE STONE FOUNTAINS	115 - 125
OUR NURSERY	127 - 129
QUALITY TIME AND POLICY OBJECTIVE	131
SAFETY POLICY & PRIORITIES	133 - 135
DOCUMENTS & CLASSIFICATIONS	137 - 141



Our Company & Team

AL SULAITEEN GARDENS work is based on a thorough understanding of the physical characteristics of the site and the dry hot climate. Our approach is to develop a unique and cost-effective solution using a broad range of materials, finishes, and water features. Behind any great garden has to be a great team, **AL SULAITEEN GARDENS** is consist of professional Staffs, Engineers and Labors to meet your clients standards. Our ability to deliver outstanding results in our work starts with our team of smart, capable landscape & gardening experts.





Introduction

AL SULAITEEN GARDENS is member of Al Sulaiteen Group of Companies Specializing in the villa landscaping and home gardening , we as **Al Sulaiteen Gardens** are committed to provide Natural and artificial gardening high level services to potential clients with full satisfactory and as per expectation level of client. As each of our Clients has dissimilar needs and concepts, so all of our ideas are unique and customize to satisfy each customer in a distinctive way. No matter what style of design or service you required. Al Sulaiteen Gardens could help you the utmost quality of exceptional services, while ensuring you are delighted with the completed project. We endeavour for perfection and maintain to build on a reputation of pristine and creative ideas, sturdy professional techniques and landscaping ethics.

Our nursery division at Umm Salal Ali farm produces most of the plants, ground covers & trees needed for landscaping projects especially atier newly up-to-date nursery extension.

Environmental Awareness

Al Sulaiteen Gardens is very mindful of the impact of its products on the environment. Wherever possible we promote the use of endemic plants, ecologically friendly inputs, and water wise solutions.





Our Services

As one of the leading gardening and landscaping organization in the region, **AL SULAITEEN GARDENS** is committed to deliver the highest quality of services within the agreed framework of design, cost, time and quality through a carefully managed procurement process. We pride ourselves in offering the following:

➤ **DESIGN:** We work with our valued customer to develop a beautiful and impressive Landscape Design, adding to the enjoyment of perfectly landscaped garden. We provide the highest quality service and a satisfactory finished project. **Under our Landscape Design includes: Soft and Hardscape, Irrigation Design.**

➤ **CONSTRUCTION:** Our mission at **AL SULAITEEN GARDENS** is to help you turn your landscape vision into a reality. We offer a wide range of services, from basic consultation and guidance on small restoration projects to brand new installation. Under our construction services includes: Soft and Hardscape, Irrigation, Lighting, Fountain & Football Fields.

➤ **MAINTENANCE:** We provide the best garden maintenance service and quality landscaping. We know how the importance of garden and landscape of each clients that is why we offer the best professional care and landscaping maintenance. **Under our Maintenance Service includes: Soft Landscape and Irrigation.**

- Supply and Installation of **UPVC PERGOLA**
- Supply and Installation of **UPVC ARBOR**
- Supply and Installation of **KIDS PLAY EQUIPMENT**
- Supply and Installation of **ROOF GARDEN**
- Supply and Installation of **UPVC FENCING SYSTEM**
- Supply and Installation of **FOOTBALL FIELDS**
- Supply and Installation of **ARTIFICIAL GREEN WALL**
- Supply and Installation of **NATURAL GREEN WALL**
- Supply and Installation of **ARTIFICIAL GRASS**
- Supply and Installation of **NATURAL GRASS**
- Supply and Installation of **WOODEN FLOOR TILES (WPC TILES)**
- Supply and Installation of **ARTIFICIAL PLANTS & TREES**
- Supply and Installation of **RUBBER FLOORING**
- Supply and Installation of **BARBECUE GRILL**
- Supply and Installation of **GRASS FENCE**
- Supply and Installation of **PEBBLE STONES**
- Supply and Installation of **GRANITE FOUNTAINS**
- Supply and Installation of **CAR PARKING**



Soft & Hardscape Design

AL SULAITEEN GARDENS Landscape Services takes pride in our work. Our crews are professionally trained to provide the highest quality of landscape Design in the industry. **AL SULAITEEN GARDENS** Landscape Services provides all of your landscape construction needs. In good landscape design, both soft landscaping and hard landscaping are essential elements and both need consideration. A landscape can appear incomplete, and it can't perform many of the functions that good landscaping can without both hard and soft materials present. Offering a professional maintenance service matching with our designs for all the systems we install. By implementing regular maintenance schedules helps to keep project growing and improving accordingly. We offer a fully integrated management system from design phase to make achievement of measurable criteria approved jointly between the clients and ourselves.

It's always a good idea to consult with **AL SULAITEEN GARDENS** to give you some ideas of the essential components which will complete your garden design.





Irrigation Design

Our crew are planning to save water by using less time shifts to meet the plants requirements with smart irrigation designs to make it an irrigation system is easy and inexpensive. Designing an irrigation system is a complex task due to the large number of factors involved in the process.

AL SULAITEEN GARDENS are more than happy to help If you are struggling to figure out how to plan an irrigation system for your garden.

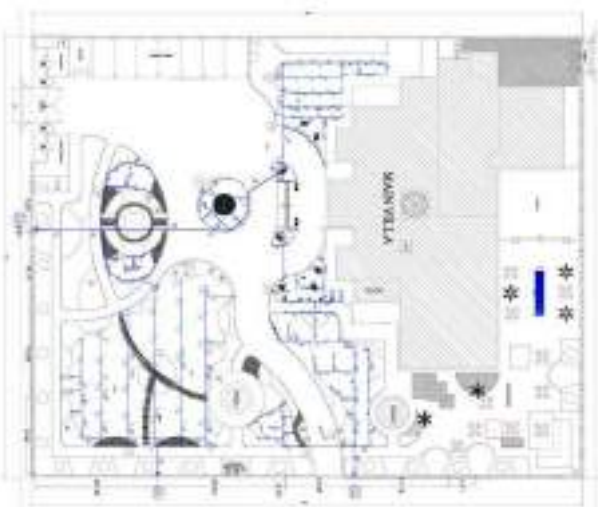
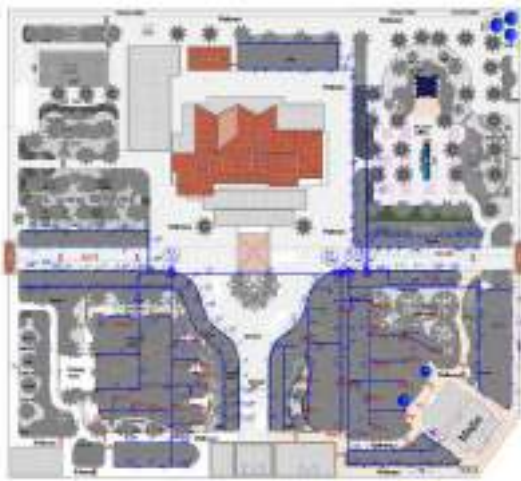



Landscape Construction Soft & Hardscape

AL SULAITEEN GARDENS Landscape Services takes pride in our work. Our crews are professionally trained to provide the highest quality of landscape construction in the industry. WE ARE providing all of your landscape construction needs. A landscape can appear incomplete, and it can't perform many of the functions, But with us we are studying how to use all items and elements on your garden, take caring about the wind, sun direction and shadows calculated from soft landscaping and hard landscaping materials integrated each other's such as walkways with trees and flowers , parking areas with shades , backyards and gardens accessories like fountains fencing system, Borders, BBQ, setting areas considering the privacy and quality for long run grantee's of all materials are supplies and installed without both hard and soft materials present. Balance between the hard and soft is needed for the whole. Much like how hardware and software are both needed to create a computer.

















Car Parking Construction

Parking structures have become important elements in your property development. The car park is the first building many visitors come into contact with and first impressions really counts.

AL SULAITEEN GARDENS specializes good car park design that includes attributes like: Uncomplicated and logical flow around the car park, spacious, safe & secure.

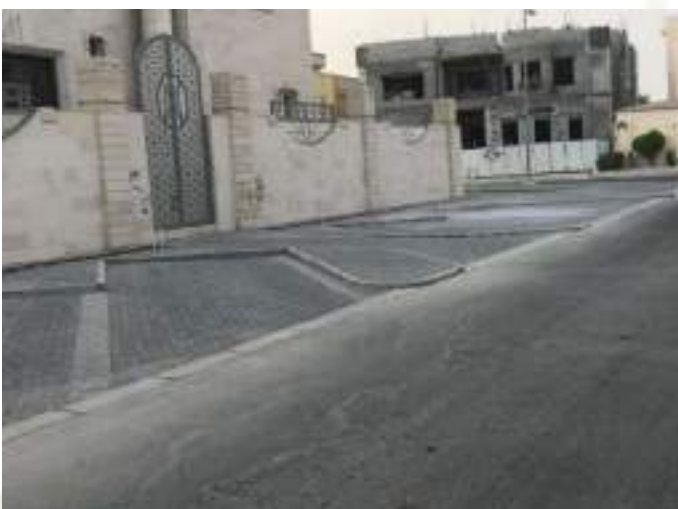



Football Fields Construction & Maintenance

We **AL SULAITEEN GARDENS** provide our customers with many possible options that best suit their requirements, to enhance and beautify their surroundings for playing. The better you regularly maintain your football field, the longer it will last. Simple economics, but often forgotten.

AL SULAITEEN GARDENS offers a variety of maintenance regimes to suit all types of surface. We do the general inspection and service work that should be carried out in a most effective way. The more frequently this maintenance and inspection work is carried out, the simpler the system-related maintenance work will be.





Irrigation Construction

AL SULAITEEN GARDENS has the experienced in all types of irrigation for lawn and garden. We are experts in the installation and maintenance of irrigation and systems for sporting fields, passive recreation areas, lawns and landscapes. We offer irrigation works services that are admired due to reasonable cost, hassle-free management, perfect execution, and client-focused approach.

Irrigation Construction has been one of the expertise we do for years in full range of services that combine our experience with the latest technology and craftsmanship. We have set the standard for irrigation by never being too comfortable with the status quo, developing new ideas, and applying those solutions that differentiate us in valuable ways to make ease maintenance.





Softscape Maintenance













Irrigation Maintenance

Even the best irrigation system can waste water if it is run too long or operated incorrectly. You might be able to save water by regularly maintaining your irrigation system. We at **AL SULAITEEN GARDENS** tests your irrigation system periodically to make sure it's operating correctly

Our teams are experts in understanding soil types and weather issues and will make irrigation suggestions accordingly. We can also diagnose and repair any problems before they permanently affect your system or your landscape. With regular irrigation system maintenance your sprinklers will last longer, be more efficient, and give your landscape more accurate watering.





Supply & Installation of Barbecue Grill

YF-01J06-B



BBQ Gas Grill YF-01J06-B (6 main + 1 side burner)

Size: 149 x 55 x 109cm

Colour: Black

Cooking Size: 76 x 41.5 cm

Warming Area: 71.5 x 10.5 cm

Cooking Height: 85 cm

Main Burner: 10000BTU x 6

Carton Size: 92 x 68 x 52 cm

G.W./N.W.: 39/31.1 kgs

YF-01J04-B



BBQ Gas Grill YF-01JY04-A (4 main + 1 side burner)

Size: 132 x 55 x 109cm

Colour: Black

Cooking Size: 60 x 41.5 cm

Warming Area: 54.5 x 10.5 cm

Cooking Height: 85 cm

Main Burner: 10000BTU x 4

Carton Size: 75 x 68 x 52 cm

G.W./N.W.: 34.6/27.6 kgs

YF-01ZW04-A



BBQ Gas Grill YF-01JY04-A (4 burners)

Size: 132 x 55 x 109cm

Colour: Silver

Cooking Size: 60 x 41.5 cm

Warming Area: 54.5 x 10.5 cm

Cooking Height: 85 cm

Main Burner: 10000BTU x 4

Carton Size: 75 x 68 x 52 cm

G.W./N.W.: 32.2/25.2 kgs



Supply & Installation of UPVC Pergola

3m x 3m TRELLIS PERGOLA (VA42081)



Dimensions:

120" L x 120" W x 96" H
(304.8 cm x 304.8 cm x 243.8 cm)

4m x 4m REGENCY PERGOLA (VA42055)



Dimensions:

144" L x 144" W x 105.75" H
(365.8 cm x 365.8 cm x 268.6 cm)

4m X 4m MONTEREY CANOPY PERGOLA (VA42073)

Dimensions:

144" L x 144" W x 105.75" H
(365.8 cm x 365.8 cm x 268.6 cm)



4m X 4m FREEMONT ATTACHED PERGOLA (VA42044)

Dimensions:

144" L x 144" W x 105.75" H
(365.8 cm x 365.8 cm x 268.6 cm)



4m x 4m CAMRY LOUVERED PERGOLA (VA42070)



Dimensions:

144" L x 144" W x 105.75" H
(365.8 cm x 365.8 cm x 268.6 cm)

4m X 4m ELYSIUM ATTACHED PERGOLA (VA42072)



Dimensions:

144" L x 144" W x 105.75" H
(365.8 cm x 365.8 cm x 268.6 cm)

4m x 5m BARCELONA PERGOLA (VA42028)

Dimensions:

192" L x 144" W x 108" H
(365.8 cm x 487 cm x 274.32 cm)



4m x 5m VALENCIA ATTACHED PERGOLA (VA42086)

Dimensions:

192" L x 144" W x 106" H
(487.7 cm x 365.8 cm x 269.2 cm)



4m X 8m REGENCY GRANDE PERGOLA (VA42083)



Dimensions:

283" L x 144" W x 105.75" H
(718.8 cm x 365.8 cm x 268.6 cm)





Supply & Installation of UPVC Arbors

FAIRFIELD DELUXE ARBOR (VA84242)

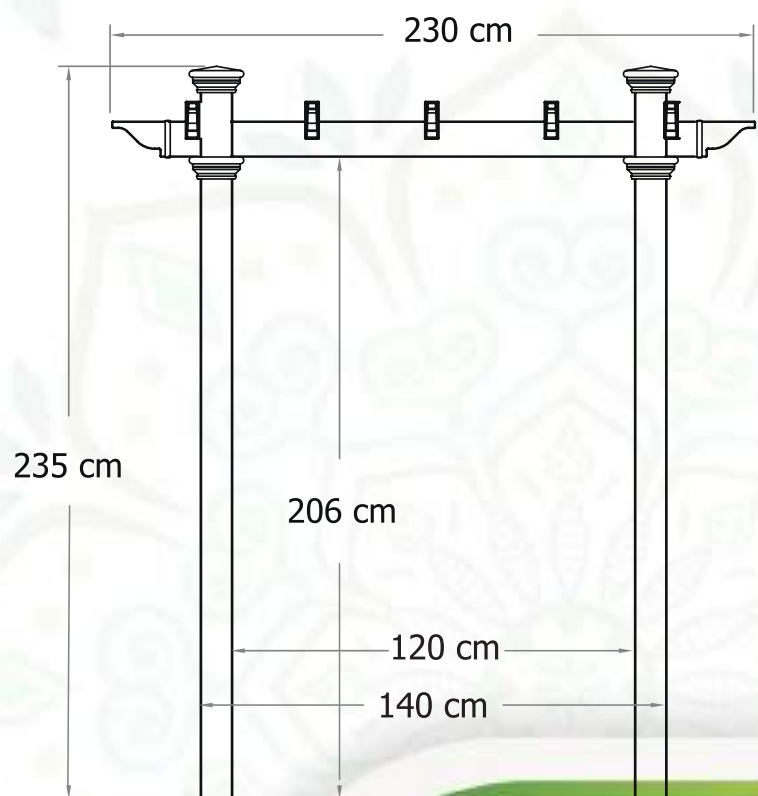
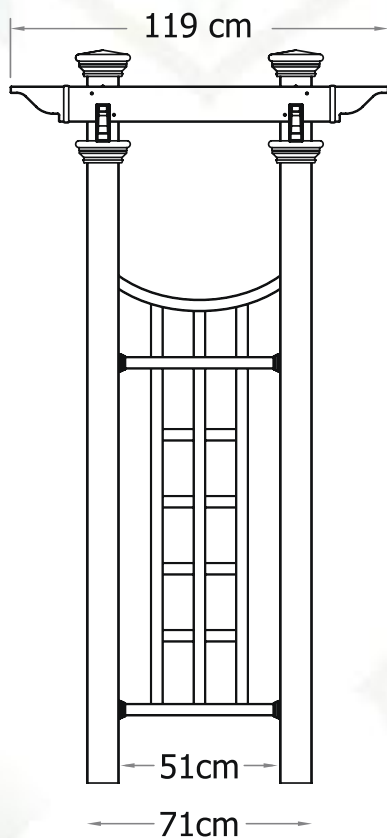

NANTUCKET LEGACY ARBOR (VA84250)

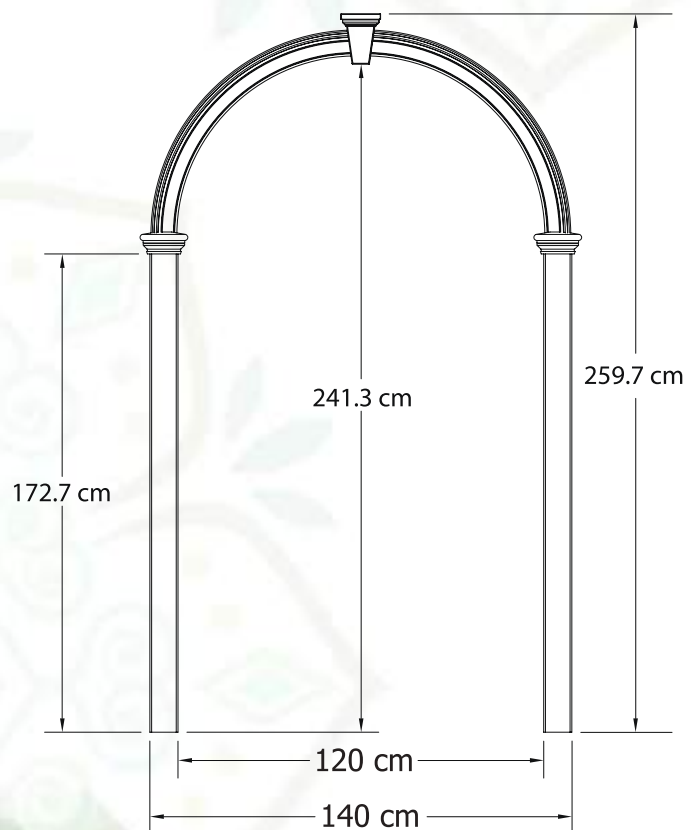
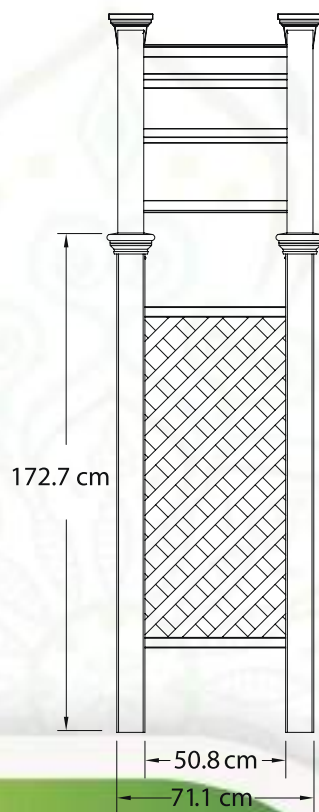

UPVC Arbors



Artificial Westwood Arbors

HEARTWOOD ARBOR (VA68897)

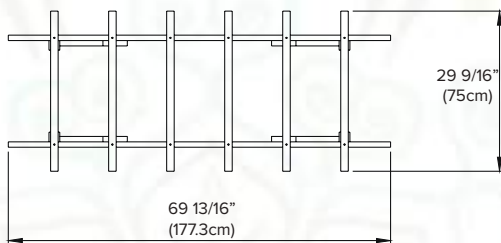

TOP VIEW

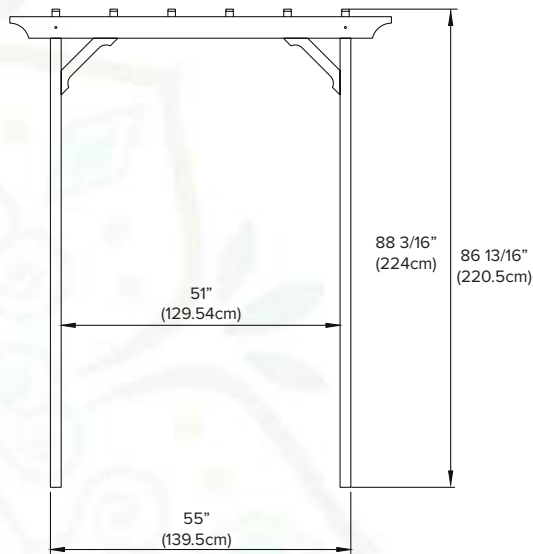

FRONT VIEW

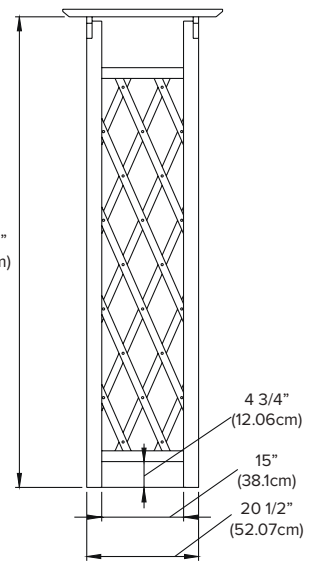

SIDE VIEW

WESTWOOD ARBOR (VA68890)

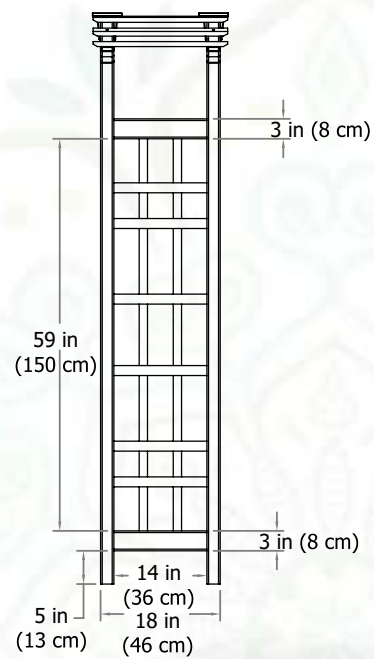
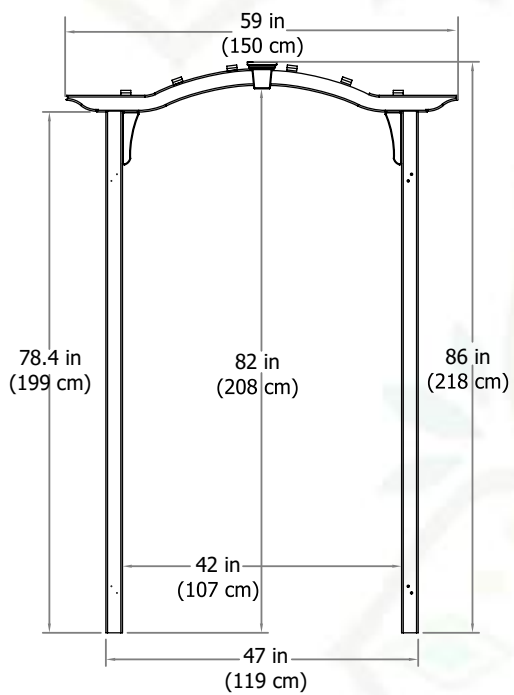

HEARTWOOD GRANDE ARBOR (VA68898)

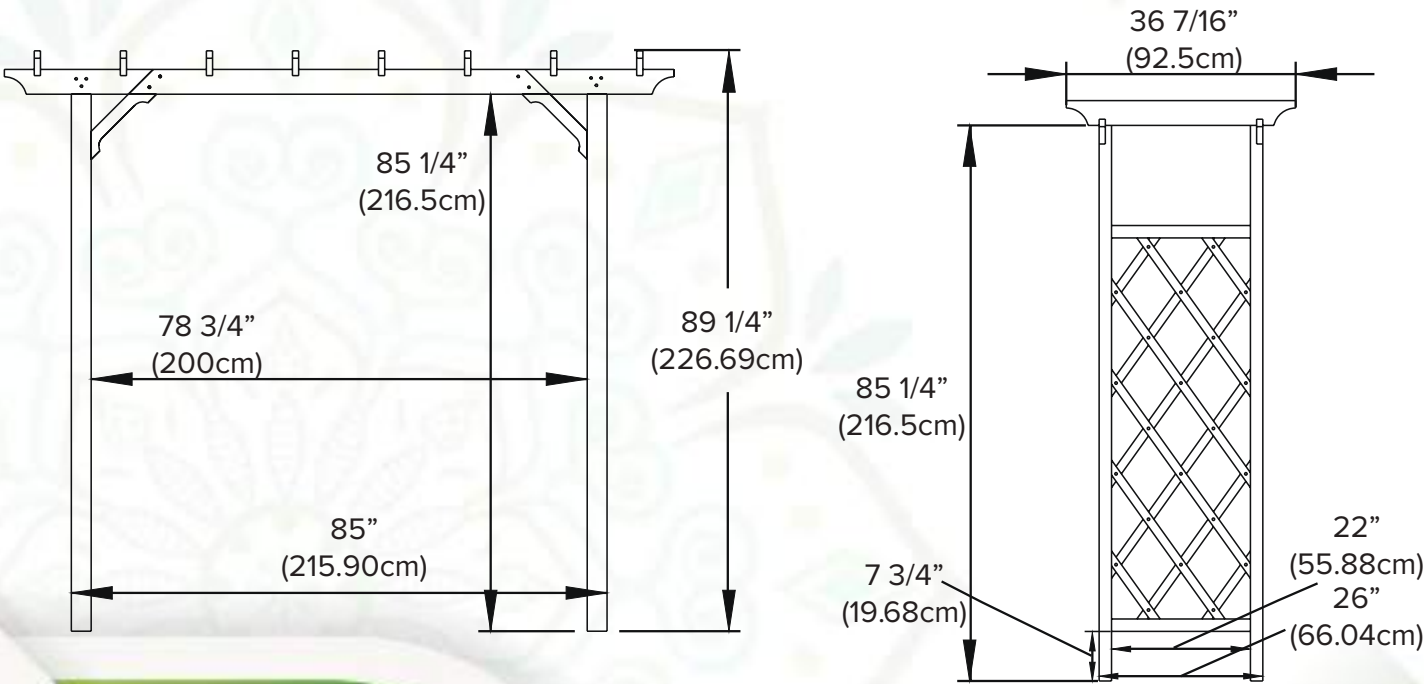

ROSEWOOD ARBOR (VA68894)

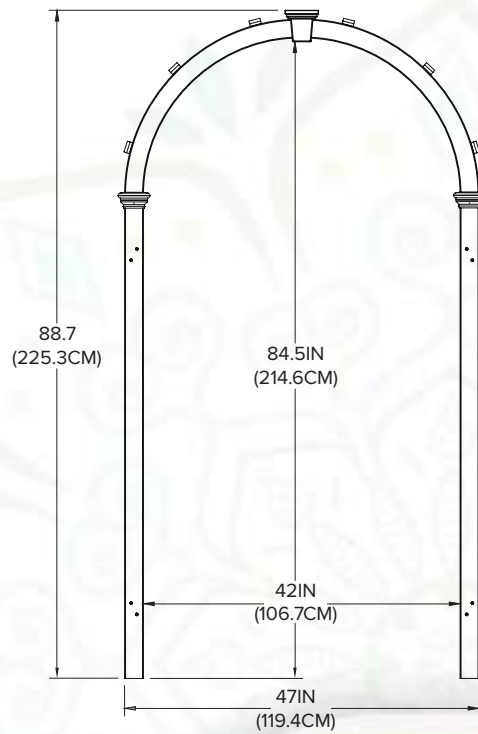
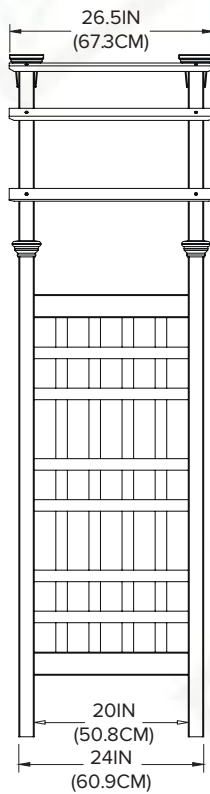

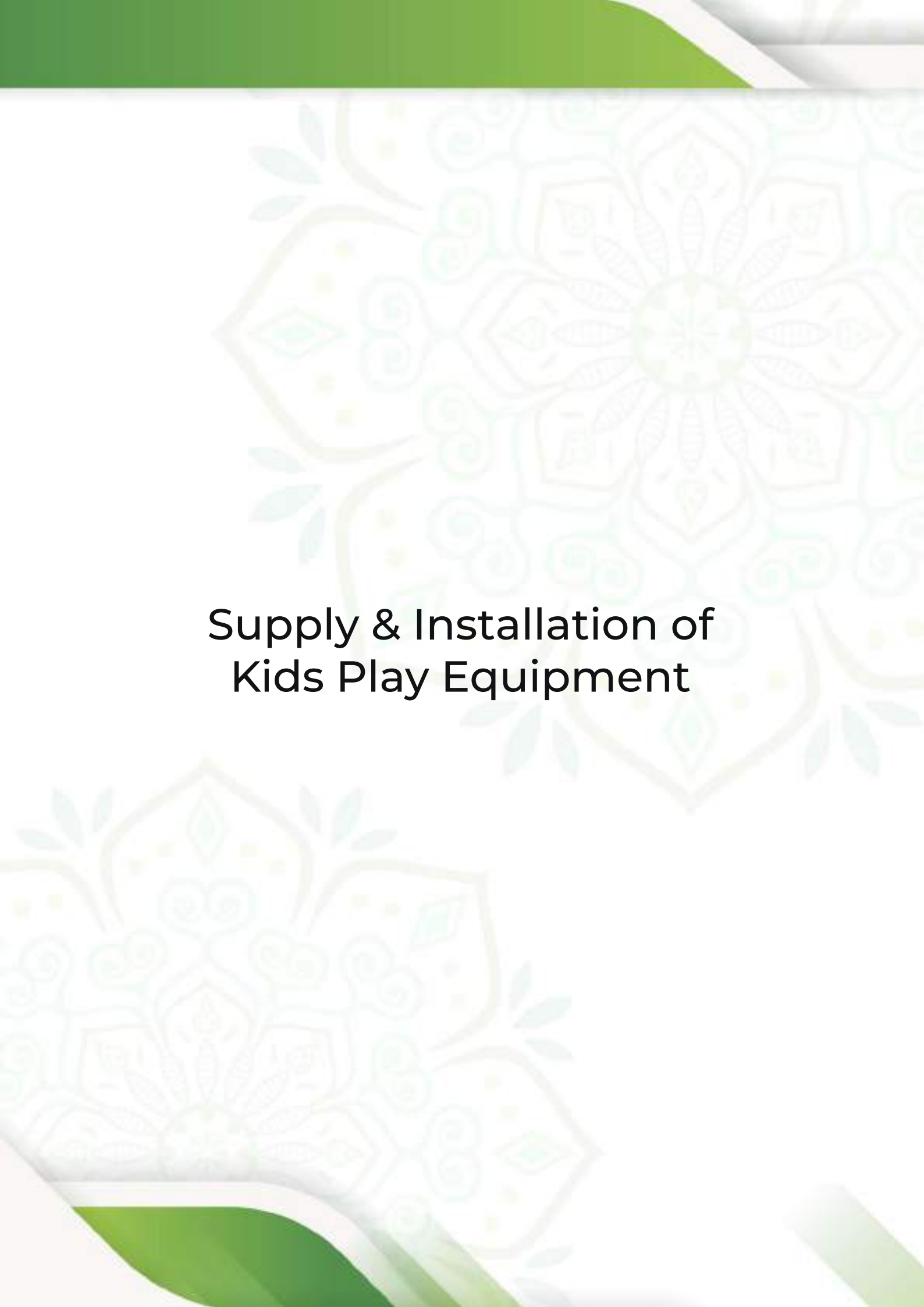

Supply & Installation of Kids Play Equipment

We know outdoor play is essential to the development of all children, which is why our play structures encourage children to explore the world around them and learn fundamental lessons through imagination, adventure and play.

AL SULAITEEN GARDENS operates in supplying and installing kids play equipment made in Turkey. We demonstrate the care to your beloved children by choosing the safe products that do not harm the health of your young ones. Our employees takes the necessary measures of safety while supplying and installing our products.

AL SULAITEEN GARDENS supplies kid's playground equipment that is designed with safety and durability in mind, so you always know that you will receive the highest quality products with less worries and full security.



ZP2012
HILL HEIGHT: 80cm
DIM: 60cm x 45cm



ZP2009
HILL HEIGHT: 80cm
DIM: 45cm x 80 cm



BD701
ALMOND SERIES
HILL HEIGHT: 4.5 mtrs
DIM: 5.5 mtrs x 6 mtrs



TR402
TREE SERIES
HILL HEIGHT: 4.5 mtrs
DIM: 6 mtrs x 6 mtrs



ZP2011
HILL HEIGHT: 95cm
DIM: 75cm x 45cm



ZP2010
HILL HEIGHT: 80cm
DIM: 60cm x 45cm

LY-C6012

KIDS TABLE & CHAIR
(2 IN 1)



SPECIFICATIONS:

Material: HDPE Hard Plastic
Dimensions: 63 x 49 x 51cm

LY-C1009

COMBINATION SLIDE



SPECIFICATIONS:

Material: HDPE Hard Plastic
Dimensions: 160 x 170 x 114cm

LY-19902

SLIDE & SWING
(2 IN 1)

SPECIFICATIONS:

Material: HDPE Hard Plastic
Dimensions: 280 x 225 x 165cm



LY-09007

FOREST PLAYGROUND



SPECIFICATIONS:

Material: HDPE Hard Plastic
Dimensions: 461 x 300 x 218cm

LY-06203

SLIDE



SPECIFICATIONS:

Material: HDPE Hard Plastic
Dimensions: 300 x 75 x 175cm

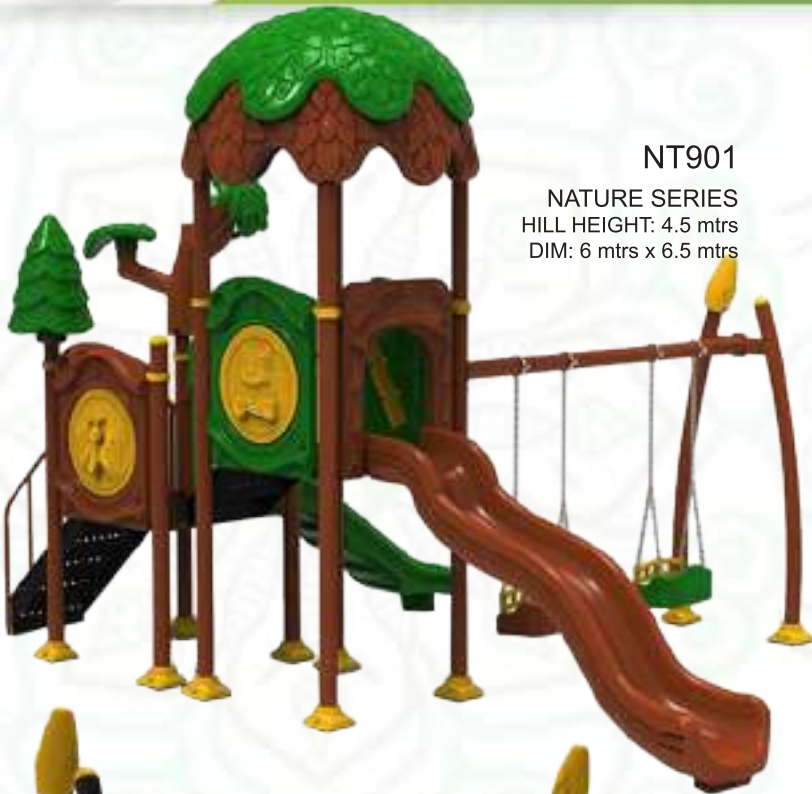

NT901
NATURE SERIES
 HILL HEIGHT: 4.5 mtrs
 DIM: 6 mtrs x 6.5 mtrs



ZP2013
 HILL HEIGHT: 80cm
 DIM: 45cm x 100cm



DD2204
 HILL HEIGHT: 90cm
 DIM: 1.5 mtrs x 5.5 mtrs



SW1802
 HILL HEIGHT: 4.5 mtrs
 DIM: 6 mtrs x 6.5 mtrs



BNK3110
 56 x 79 x 150cm

TCS3204
 52 x 52 x 78cm



BNK3108
 42 x 45 x 170cm

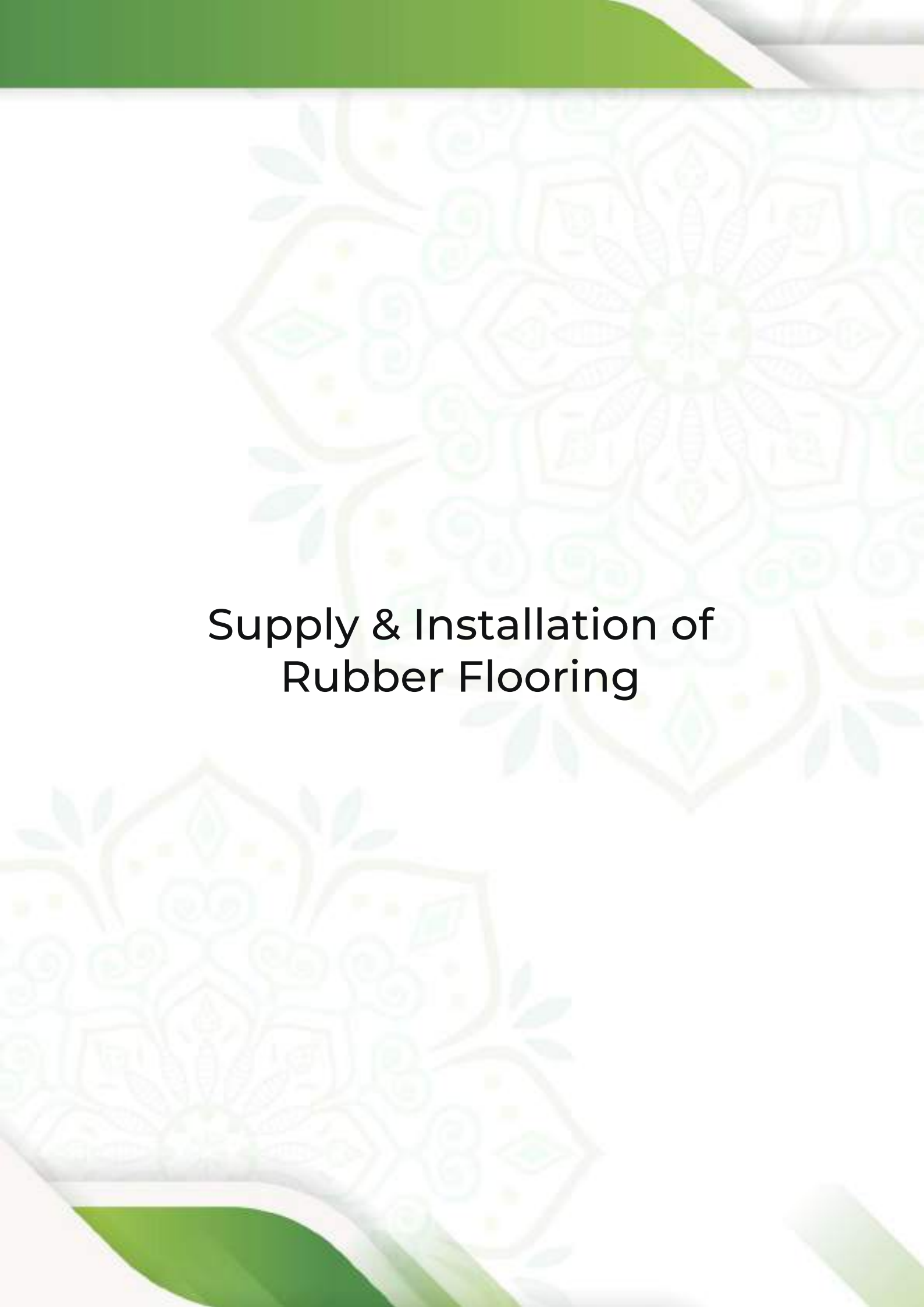

Supply & Installation of Rubber Flooring

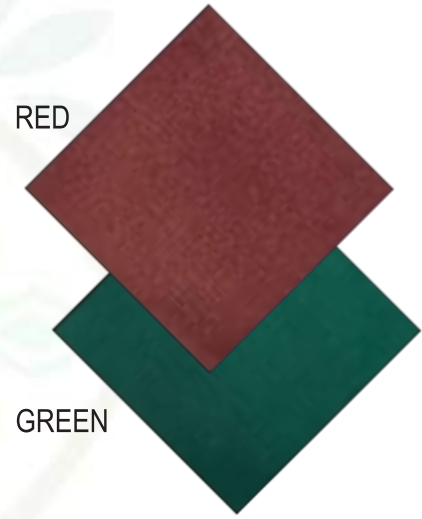

Dimension: 40 x 40 x 2cm



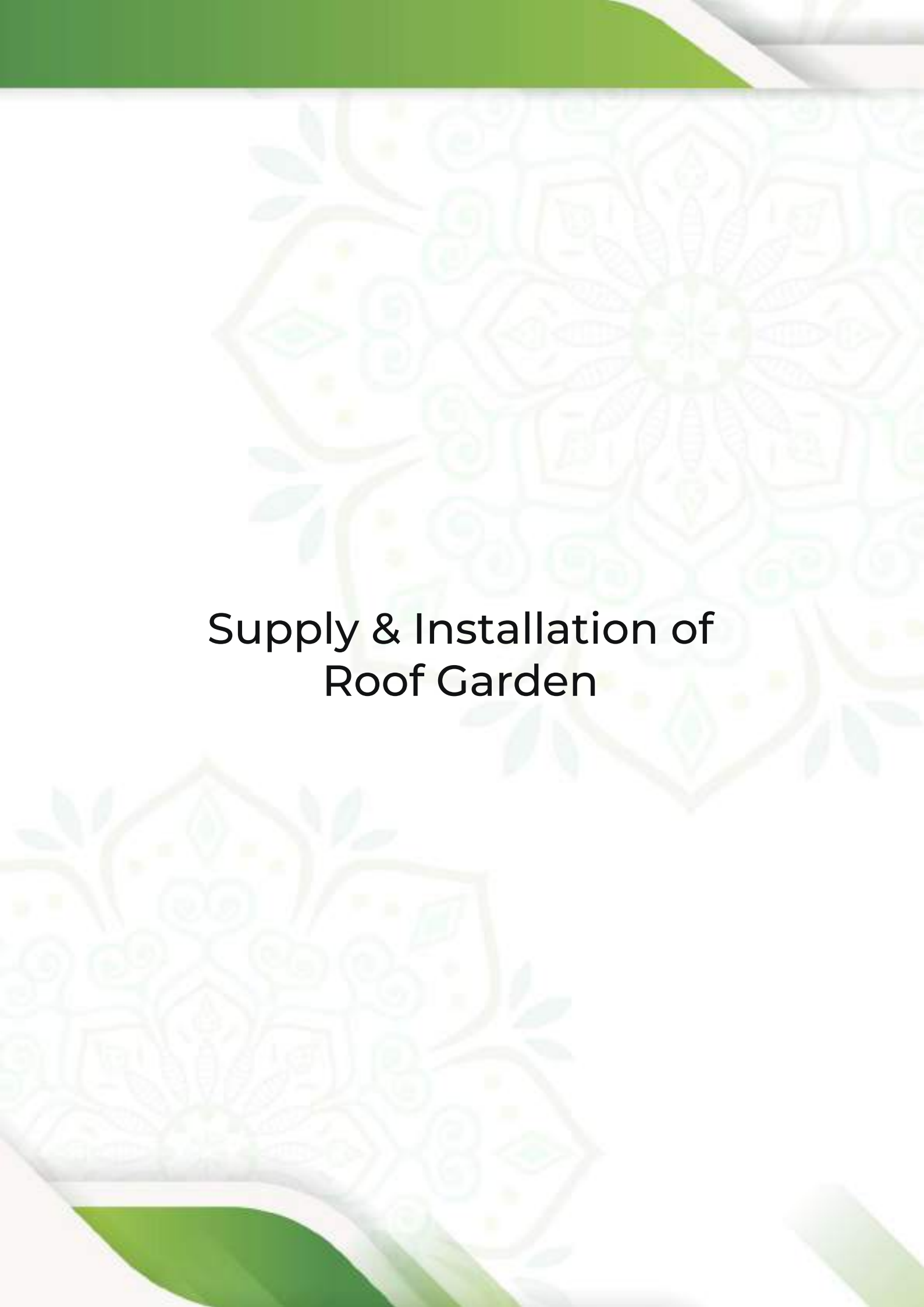

Supply & Installation of Roof Garden

A roof garden is generally used as an additional outdoor living space in an urban environment where your dreams of having a garden may be difficult to achieve. So don't be sad that you don't have enough space in front or back of your house.

We **AL SULAITEEN GARDENS** are specialized in supply and installation Roof gardens have a positive effect on the environment by reducing pollution and making your house attractive and beautiful mixing between artificial and natural plants to make you feels better and happy.



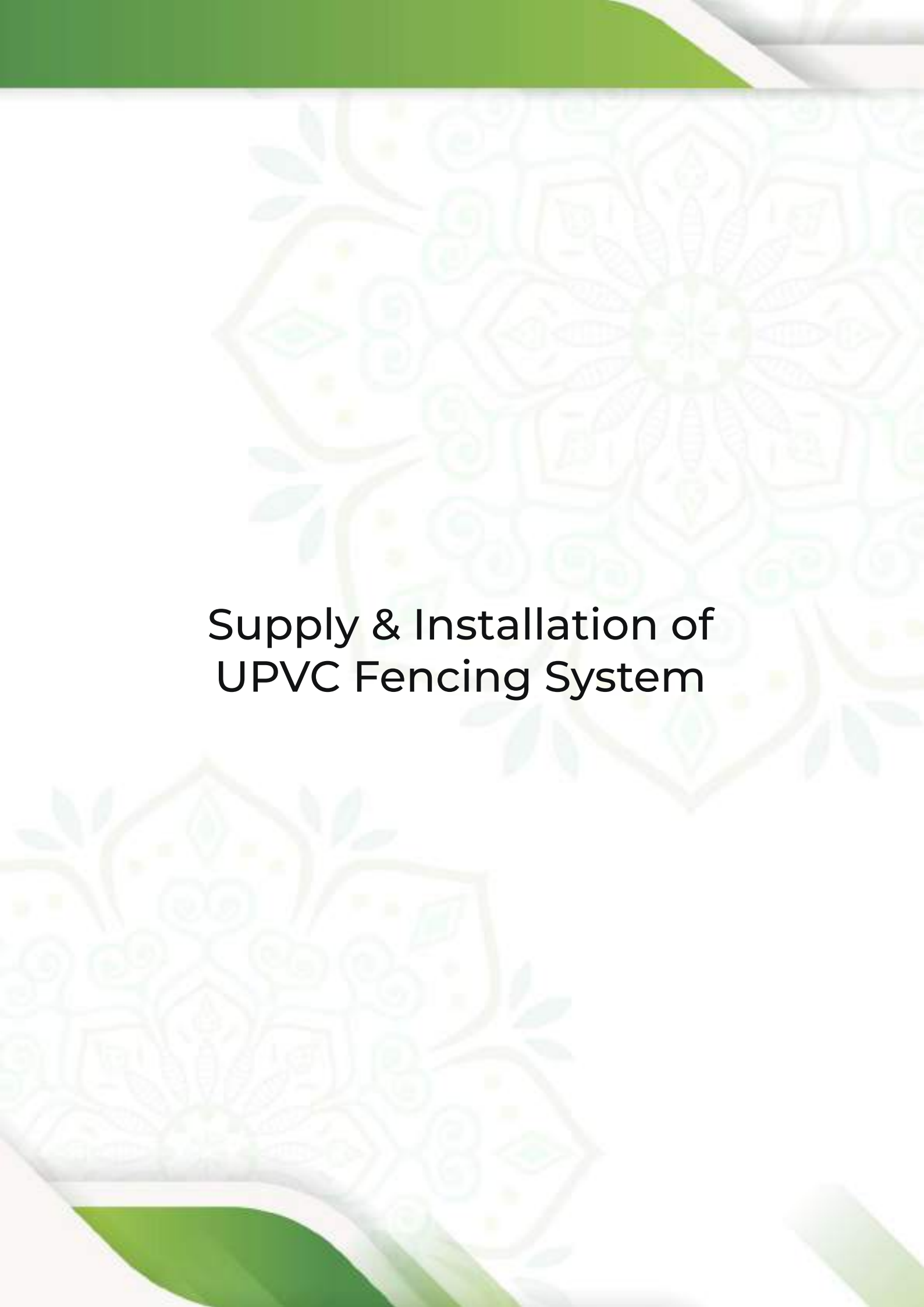

Supply & Installation of UPVC Fencing System

Fencing make your garden, Pool, playground and farm or estate even more beautiful. We **AL SULAITEEN GARDENS** provides commercial and residential security fencing options. We supply and install high quality UPVC fencing, decking and gates. We have many different types and styles for you to choose from and should have something to suit every taste and at affordable and attractive prices. Our available types includes: **Straight, Scalloped, Private and Portable UPVC Fences**. No more painting or replacing your fence due to normal wear and tear! From protecting your children, to preserving old-growth forests, vinyl is the environmentally wise choice. Our fences and gates are manufactured in hardwearing UPVC plastic, most of all it is safe!

UPVC STRAIGHT FENCE (PVC Fence001)

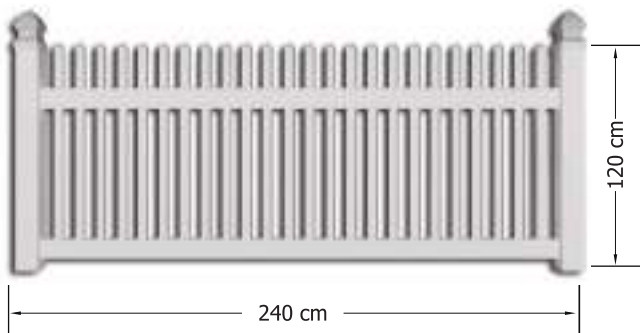

Garden UPVC Straight Fence:

- a) Size: 2.4 m width x 1.2 m height
- b) Cross bar: 20mm x 46mm, with steel insert 15mm x 30mm
- c) Vertical bar: 20mm x 46mm @ 120mm distance
- d) Post: 35mm x 56mm, with steel insert 30mm x 50mm
- e) Color: white

UPVC SCALLOPED FENCE (PVC Fence001)

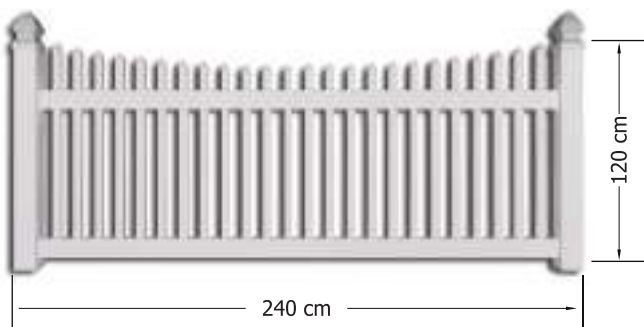

Garden UPVC Scalloped Fence:

- a) Size: 2.4 m width x 1.2 m height
- b) Cross bar: 20mm x 46mm, with steel insert 15mm x 30mm
- c) Vertical bar: 20mm x 46mm @ 120mm distance
- d) Post: 35mm x 56mm, with steel insert 30mm x 50mm
- e) Color: white

UPVC DELUXE PRIVACY FENCE

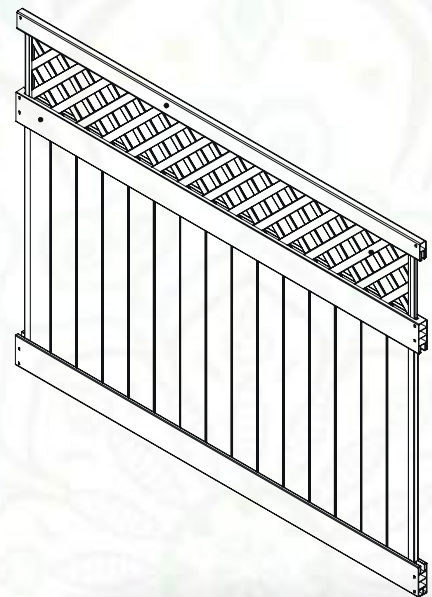
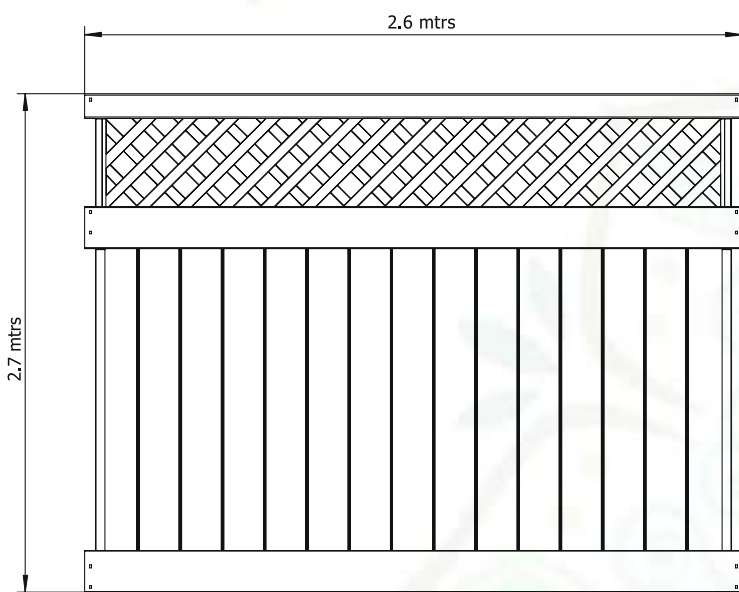

UPVC PORTABLE FENCE (PVC Fence011)

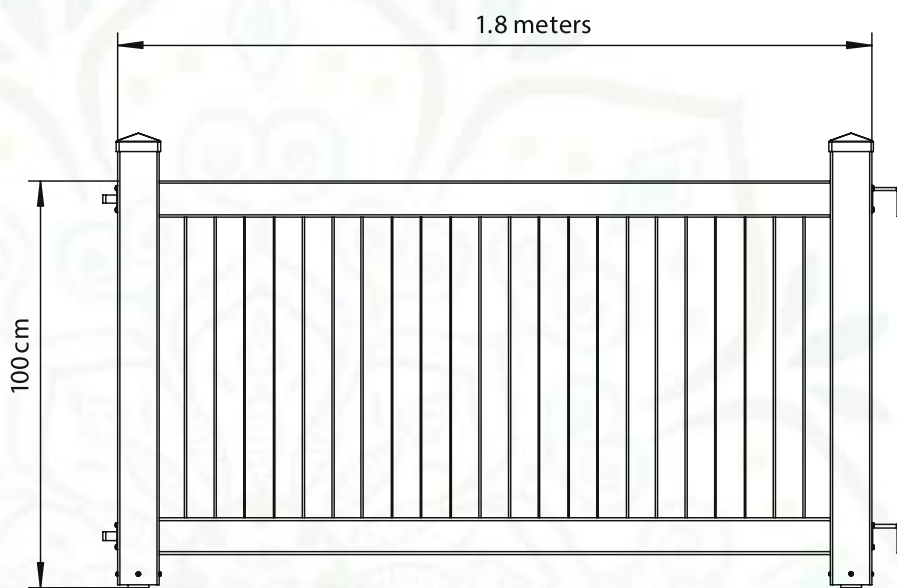

UPVC COTTAGE PICKET WINGS

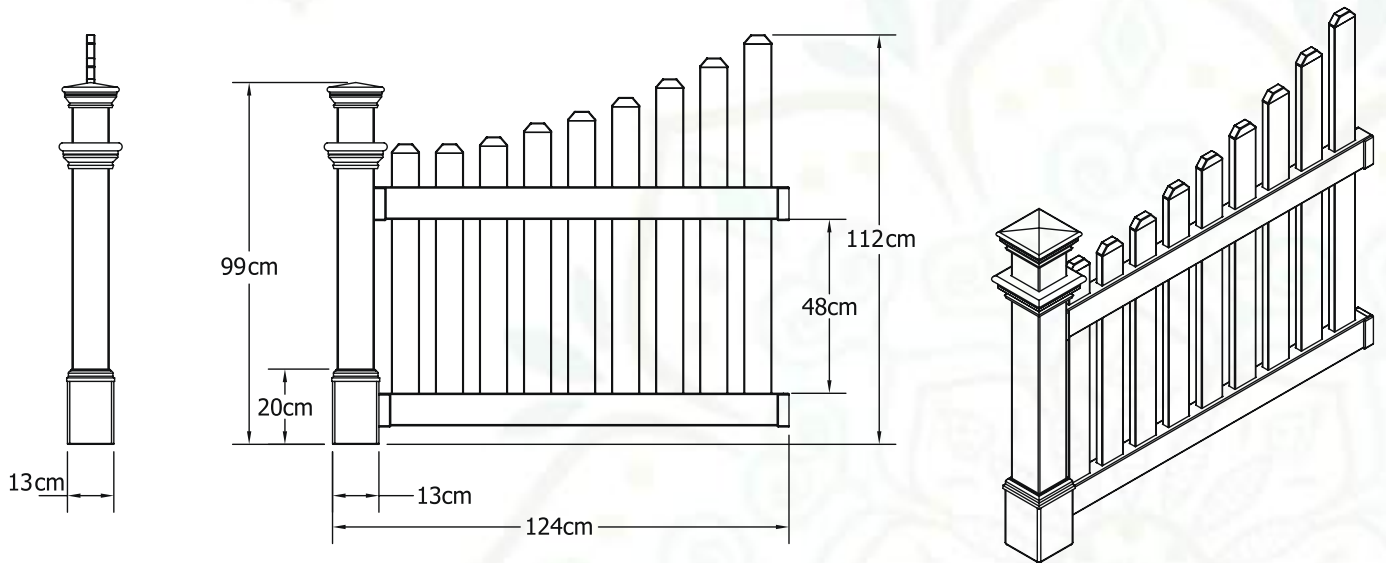



Supply & Installation of Artificial Green Wall

AL SULAITEEN GARDENS design, supply & install incredibly realistic high quality artificial green walls are applied with ultra violet protection to be installed in any space imaginable whether commercial & residential – interior & exterior. As we become more environmentally aware, interior gardens maximizing space by planting vertically are becoming popular in public and private buildings. This is where our supply and installation of green wall becomes the solution of choice.

Our Artificial Green Wall is perfect for those who want to be surrounded by plants, but do not have the time or growing conditions to face the challenges and expenses to maintain a real plant living wall.



Model No. B051-JM
Dimensions:
100cm x 100cm



Model No. L025
Dimensions:
100cm x 100cm



Model No. B053
Dimensions:
100cm x 100cm



Model No. MZ188009A

Dimensions:
50cm x 50cm



Model No. MZ188024C

Dimensions:
50cm x 50cm



Model No. MZ188026A

Dimensions:
50cm x 50cm



Model No. MZ188024H

Dimensions:
50cm x 50cm



Model No. MZ188A025

Dimensions:
50cm x 50cm







Supply & Installation of Natural Green Wall

AL SULAITEEN GARDENS is very professional in creating an atmosphere that you like being in – physically and mentally. Natural Green walls are environmentally-friendly walls of plants, which can be placed indoors and outdoors.

With our design of natural green walls you will experience a long list of improvements to your environment green walls reduce noise, clean the air of dust, improve air quality by stabilizing humidity levels integrated with automatic irrigation system , The result of being surrounded by greenery is clear to make you feel better!





Supply & Installation of Artificial Grass

We **AL SULAITEEN GARDENS** are specialist to install artificial Grass on the hardscape area including the roof gardens, public gardens, entrance of hotels, homes or to install it on wide landscape area outdoor and indoor use with 5-7 years guarantee.

As one of the largest suppliers and installer of artificial grass in the country, we offer you an unrivalled service of authentic-look lawn surfaces for gardens to suit a variety of applications. If you are looking for an artificial grass garden that looks and feels like the real thing we provide everything from supply, installation and maintenance.





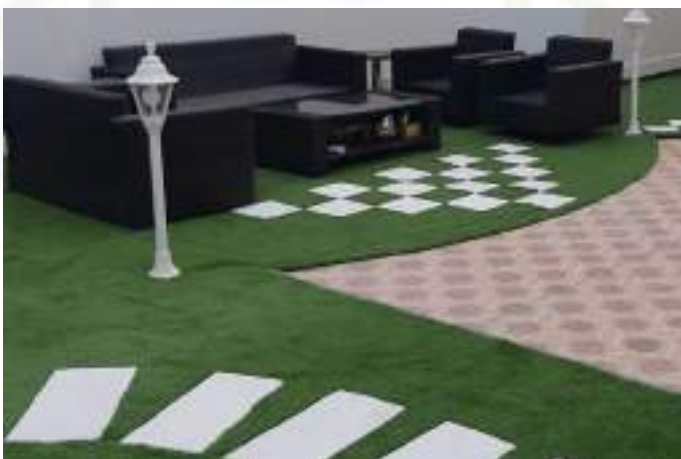

ARTIFICIAL GRASS COMBERS & SWEEPERS

ROLL & COMB 141E-V19
(59-0009)



ROLL & COMB 602QG-V19
(59-0013)



BEST 710DPG-V20 (41-0199)



ROLL & COMB 302E-V19
(59-0010)



GAS 500 G-V18 (44G-0014)



APACHE 1275 ZSL-V19



INDIANA 10 (40G-0146)





Supply & Installation of Artificial Plants

We at **AL SULAITEEN GARDENS** know how important it is for your property and business to save water and energy to feel high control of surrounded environment. Impress guests and customers with beautiful displays of artificial Trees, plants and flowers while saving money on installation and care. In addition, our professional designers and workers department can give you new ideas of projects. Therefore, we have confidence that we can be a trustable partner of you!



SJSY29
CACTUS PLANT
103CM



SJ186
BARBADOS ALOE
58CM



SJ187
BARBADOS ALOE
50CM



SJ185
BARBADOS ALOE
68CM



SJ095
ARECA PLANT (MEDIUM)
105CM



SJ097
ARECA PLANT (BIG)
165CM



SJSY09
ARECA TREE
170CM



SJSY06
PANDAN TREE
120CM



SJ136
SANSEVIERIA
TRIFASCIATA
103CM



SJ134
SANSEVIERIA
TRIFASCIATA
75CM



SJSY01
FURCRAEA
60CM

SJSY18
MONEY LEAF
30CM



SJSY12
SEVEN STARS
LEAVES
75CM



SJSY13
SEVEN STARS
LEAVES
105CM



SJSY31
OLIVE TREE
180CM



SJ280
CALAMUS
90CM



SJ268
DRACEANA
ARBOREA
180CM



SJ265
DRACEANA
ARBOREA
120CM



SJ302B
ZEBRA PLANT
54CM

ROSE FLOWER (BUNCH)



SJSY38
RED
45CM



SJSY39
WHITE
45CM



SJSY40
PINK
45CM



SJGY07
AGAVE BONSAI
150CM

AGLAONEMA BREVISPATHUM

SJSY45
140CM

SJ323
45CM

SJSY20
25CM



SJSY22
SLEEPING
BEAUTY
55CM



SJ131
WILD TARO
25CM



SJSY34
WILD TARO
55CM





SJSY37
BAMBOO
BONSAI
200CM



SJSY36
BAMBOO (BIG)
300CM



SJAP11
BANANA
TREE
220CM

SJSY26
BAY LAUREL TREE
150CM



SJ295
GARDEN CROTON
150CM



SJ293
GARDEN CROTON
40CM



SJ294
GARDEN CROTON
100CM



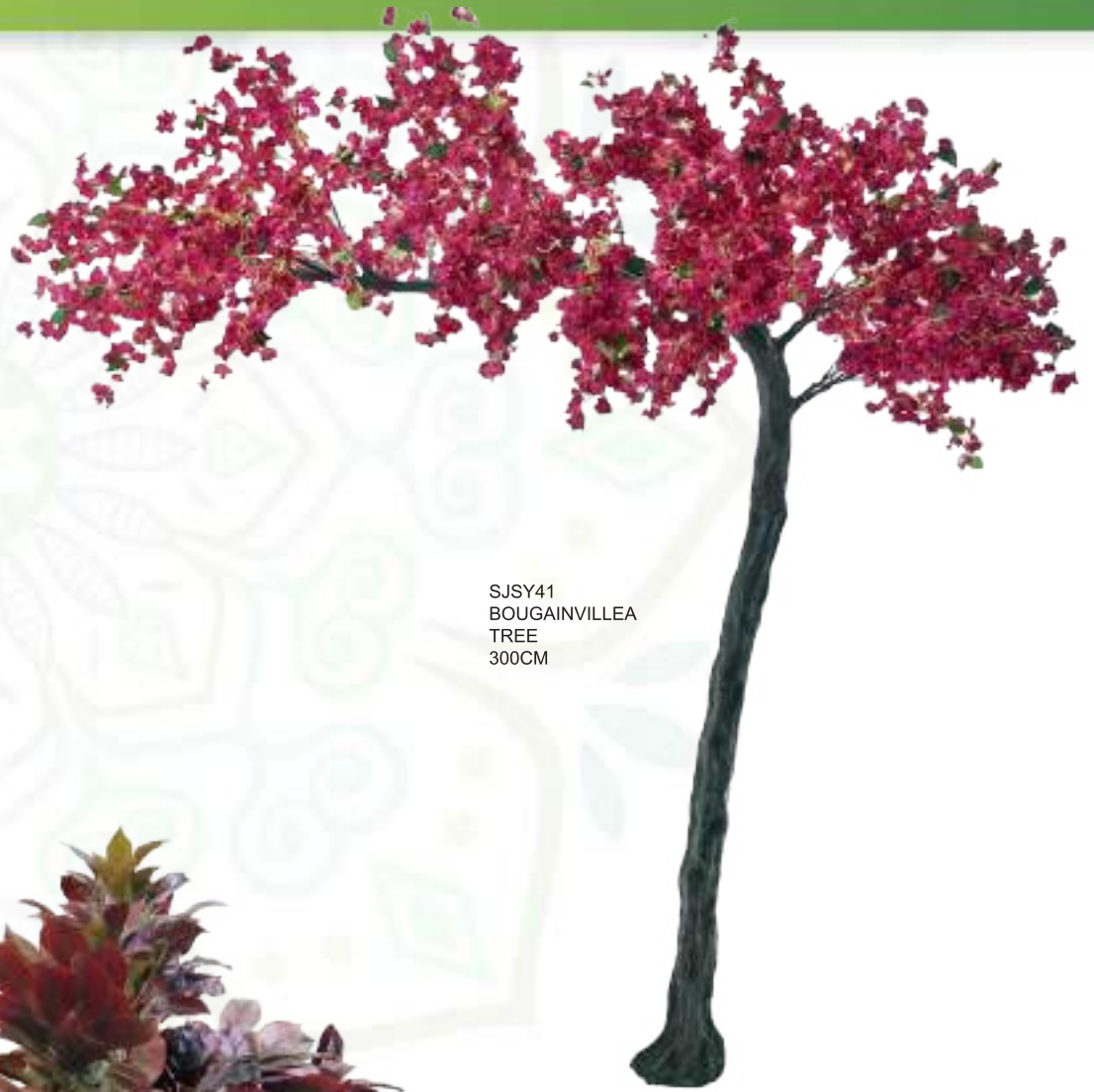

SJSY41
BOUGAINVILLEA
TREE
300CM



SJSY24
RED ADULSA
135CM

SJ049
FICUS TREE
170CM



SJ044
FICUS TREE
220CM



SJ042
FICUS TREE
120CM



SJ088
CONVALLARIA
MAJALIS
150CM



SJSY27
CONVALLARIA
MAJALIS
190CM



SJSY10
PEONY TREE
140CM



SJ153
BIRDS OF
PARADISE
180CM



SJ158
BIRDS OF
PARADISE
140CM



SJ055
MONEY TREE
145CM



SJLY02
AGLAONEMA
CORDIFOLIUM
80CM



SJ050
HAPPY TREE
150CM



SJGY13
CHINESE
BANYAN TREE
150CM



SJLY01
AGLAONEMA
CORDIFOLIUM
60CM



ARTIFICIAL HEDGE BALL



C01 - Dark Green
Inner Diam:40cm



C01 - Light Green
Inner Diam:40cm



C18
Inner Diam:40cm



C03
Inner Diam:40cm



C19 - PINK
Inner Diam:40cm



C19 - GREEN
Inner Diam:40cm



SJGY12
BIRCH TREE
250CM

SJGY10
CYPERACEAE
130CM



SJGY11
CYPERACEAE
150CM

SJGY09
CYPERACEAE
90CM



SJGY05
HEDGE BALL
TOPIARY
120CM



SJGY01
HEDGE BALL
TOPIARY
120CM



SJGY04
ARBORVITAE
SHRUBS
120CM



SJGY02
ARBORVITAE
SHRUBS
120CM



SJGY15
180CM



SJGY16
180CM



SJGY17
180CM

STRAIGHT TOPIARIES



SJ062
CHERRY TREE
3.5M



SJ020
GINKGO TREE
3.5 METERS

SJ024
LUCKY TREE
3.5 METERS



SJ064
CHERRY TREE
3M



SJ022
FICUS TREE
3.5 METERS

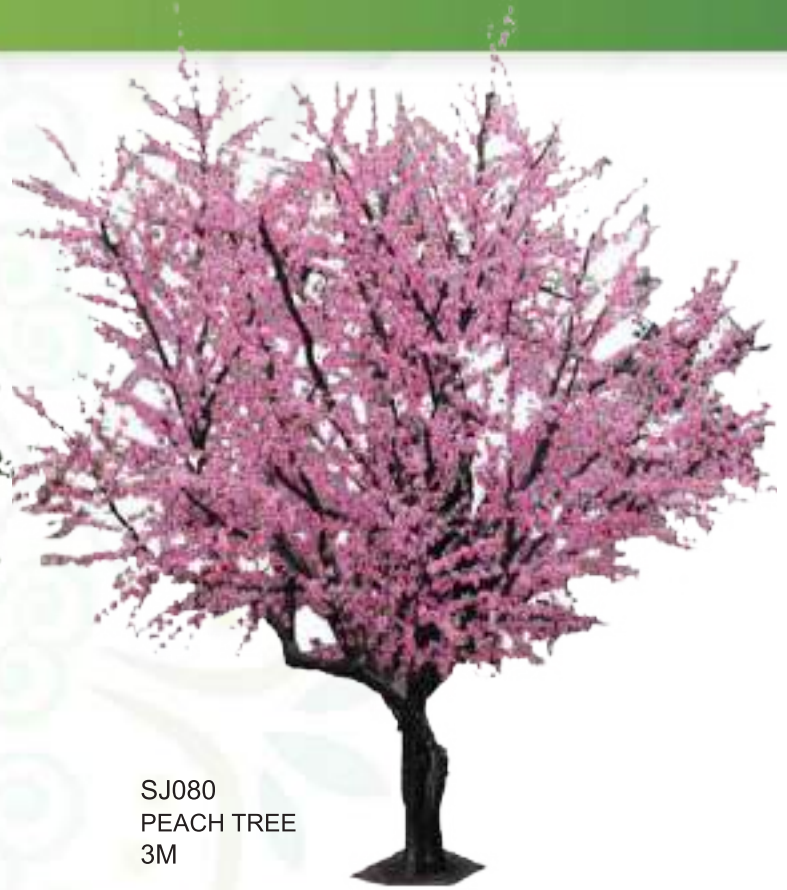

SJ080
PEACH TREE
3M



SJ025
LUCKY TREE
3.5M



SJGY14
ROYAL PALM TREE
140CM



Supply & Installation of GRP Pots



Item No. PS01

PS01-A	(22 x 20cm)
PS01-B	(28 x 26cm)
PS01-C	(35 x 32cm)
PS01-D	(43 x 41cm)
PS01-E	(52 x 48cm)
PS01-F	(65 x 65cm)
PS01-G	(70 x 70cm)
PS01-H	(80 x 80cm)



Item No. PS03

PS03-A	(44 x 22 x 20cm)
PS03-B	(56 x 27 x 25cm)
PS03-C	(76 x 34 x 32cm)

Item No. PR01



- PR01-A (32 x 27cm)
- PR01-B (40 x 33cm)
- PR01-C (50 x 42cm)
- PR01-D (65 x 49cm)
- PR01-E (75 x 56cm)

Item No. PR02



- PR02-A (35 x 30cm)
- PR02-B (44 x 42cm)
- PR02-C (53 x 47cm)



Item No. PR14

PR14-A (56 x 27 x 26cm)

PR15-B (76 x 34 x 32cm)

Item No. PS02

PS02-A (21 x 45cm)

PS02-B (27 x 55cm)

PS02-C (33 x 68cm)

PS02-D (40 x 80cm)



Item No. FS20

FS20-A (50 x 30 x 40cm)

FS20-B (50 x 20 x 40cm)



Item No. PR17



PR17-A (23 x 20cm)

PR17-B (33 x 23cm)

PR17-C (46 x 31cm)

Item No. PR05



PR05-A	(18 x 21cm)
PR05-B	(24 x 26cm)
PR05-C	(31 x 34cm)
PR05-D	(40 x 42cm)
PR05-E	(48 x 51cm)
PR05-F	(56 x 57cm)

Item No. FS19



FS19-A	(25 x 31cm)
FS19-B	(31 x 39cm)
FS19-C	(36 x 45cm)
FS19-D	(42 x 52cm)

Item No. TR08

TR08-A (33 x 72cm)

TR08-B (42 x 92cm)

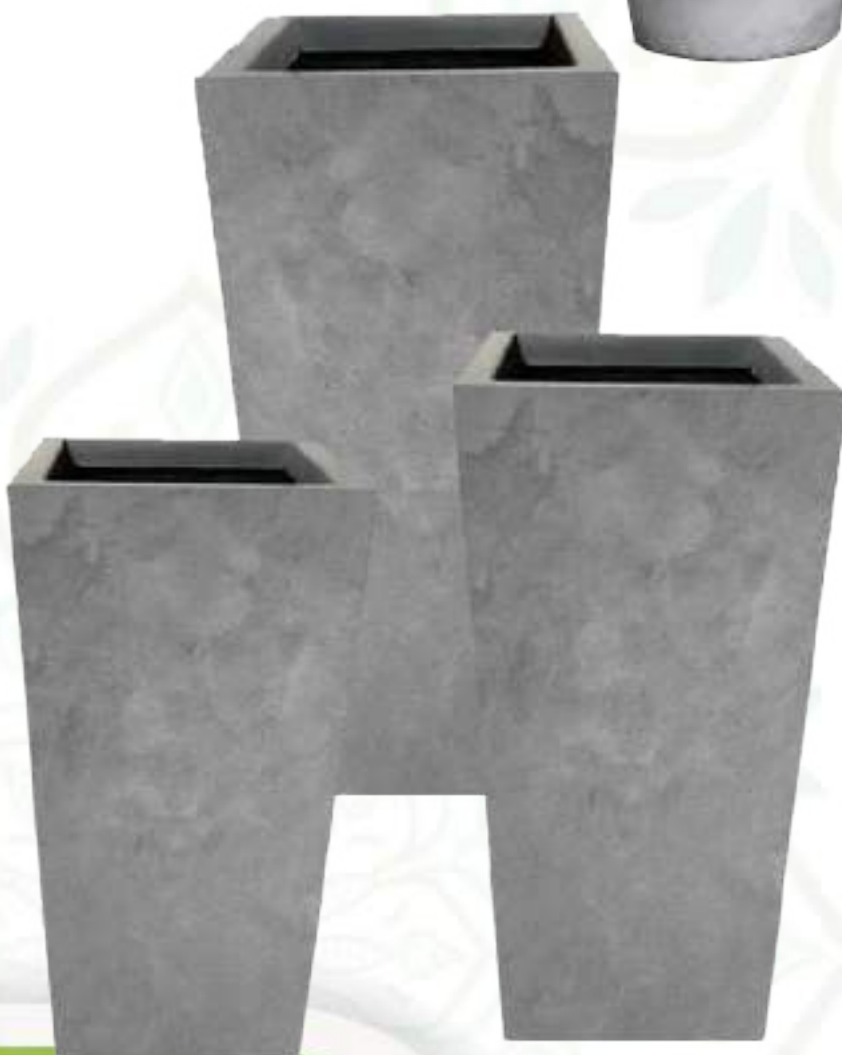

Item No. TS06

TS06-A (24 x 46cm)

TS06-B (33 x 62cm)

TS06-C (42 x 93cm)

Item No. PR23

PR23-A	(25 x 31cm)
PR23-B	(31 x 39cm)
PR23-C	(36 x 48cm)
PR23-D	(42 x 52cm)



Item No. PR09

PR09-A	(25 x 18cm)
PR09-B	(35 x 24cm)
PR09-C	(50 x 33cm)

Item No. TS09

- TS09-A (25 x 39cm)
- TS09-B (34 x 49cm)
- TS09-C (44 x 60cm)



Item No. PR15

- PR15-A (56 x 27 x 56cm)
- PR15-B (76 x 37 x 71cm)



Item No. WAT011



WAT011-A (D19 x H20cm)
WAT011-B (D28 x H31cm)
WAT011-C (D38 x H40cm)

Item No. WAT010



WAT010-A (D19 x H20cm)
WAT010-B (D28 x H31cm)
WAT010-C (D38 x H40cm)

Item No. PS12

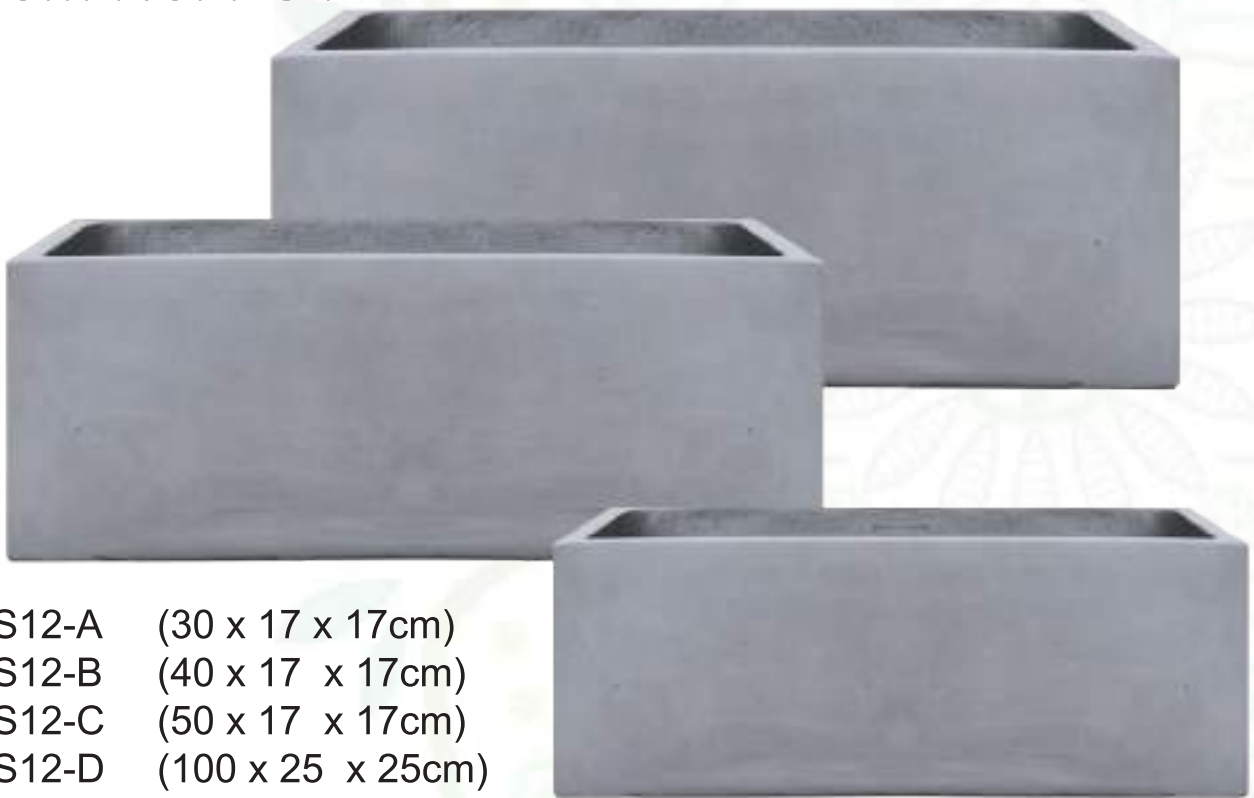

- PS12-A (30 x 17 x 17cm)
- PS12-B (40 x 17 x 17cm)
- PS12-C (50 x 17 x 17cm)
- PS12-D (100 x 25 x 25cm)



Item No. PR18

- PR18-A (42 x 24 x 22cm)
- PR18-B (52 x 30 x 27cm)
- PR18-C (65 x 38 x 34cm)



Item No. PR22

- PR22-A (38 x 38cm)
- PR22-B (46 x 55cm)
- PR22-C (54 x 70cm)



Item No. PR16

- PR16-A (25 x 50cm)
- PR16-B (30 x 60cm)
- PR16-C (35 x 70cm)
- PR16-D (40 x 76cm)



Supply & Installation of WPC Tiles

We **AL SULAITEEN GARDENS** are specialist to install WPC flooring stands for Wood Plastic Composite. These 100% waterproof engineered luxury vinyl planks and tiles are user friendly, featuring an effortless interlocking system that can be installed over most existing subfloors.

We supply & install the best WPC flooring that are hugely popular amongst the homeowners that looks for traditional hardwood without the maintenance. WPC Tiles are also one of the most popular flooring options for commercial spaces and businesses.

PRODUCT SPECIFICATIONS:

SIZE: 30 x 30cm

COLOURS: LIGHT BROWN / DARK BROWN / LIGHT GREY / DARK GREY

UV PROTECTION

WATER & MOISTURE RESISTANCE

FOR INDOOR & OUTDOOR

AREAS OF USAGES: GARDEN, SITTING AREA, WALKWAYS, SWIMMING POOL SURROUNDINGS, BALCONY, LAWNS, TERRACE



**GH - 8
LIGHT GREY**



**HS - 108
DARK GREY**



**YC49
LIGHT BROWN**



**YC2
DARK BROWN**





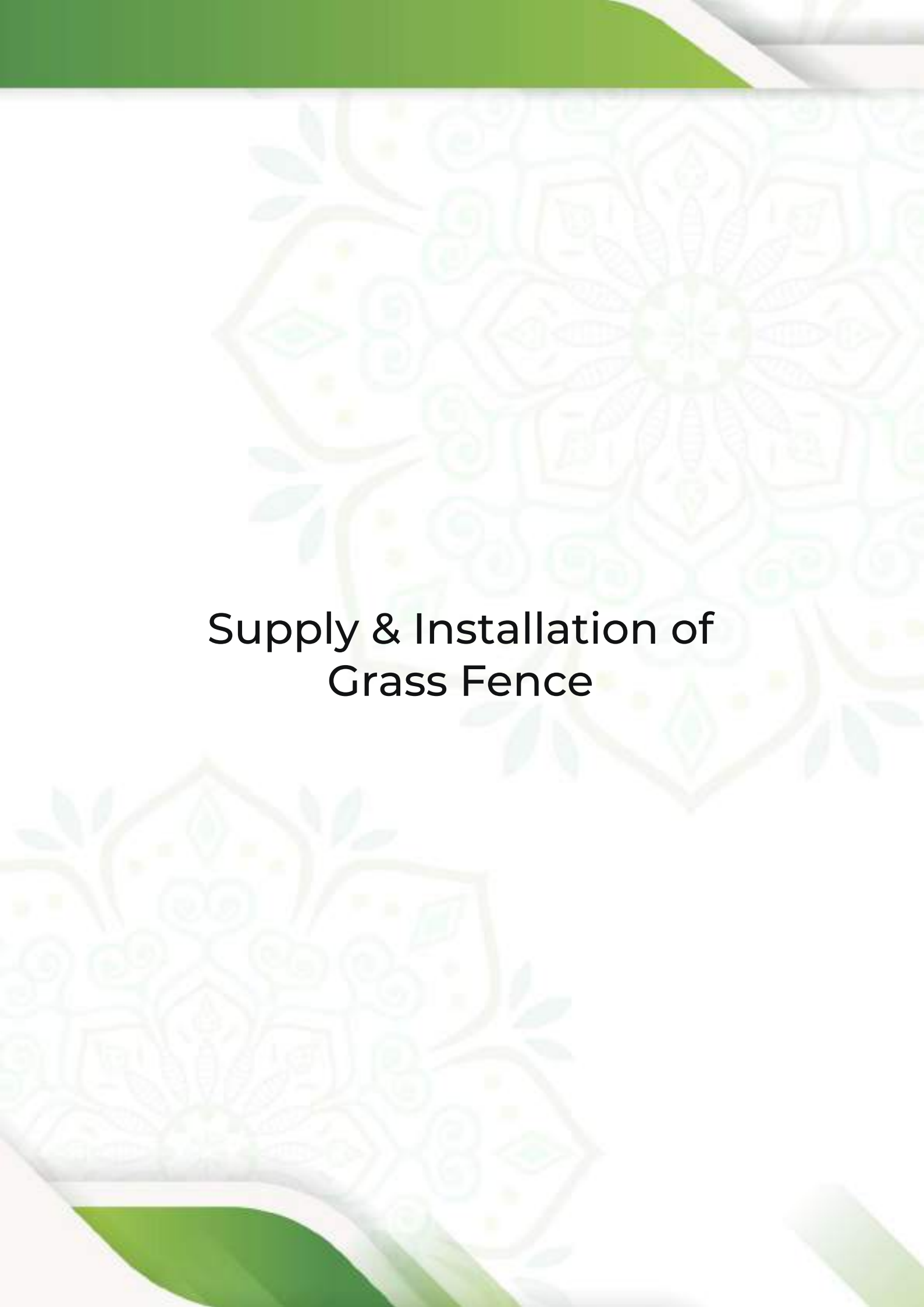

Supply & Installation of Grass Fence





Supply & Installation of Pebble Stones

We are providing pebble stones polished and unpolished type with sizes 5 – 7 cm of three colors white, black & mixed brown. It can be used for decoration of garden on the edges and surrounds of fountains, under the palm trees, entrances mixed with lighting system to give an added design on your garden.

AL SULAITEEN GARDENS are dealing with high quality pebble stones which can be used in indoor and outdoor spaces such as urban furniture around, gardens and flower pots, flower boxes, aquariums, green spaces and even artistic works due to its colors and shapes.



**BLACK PEBBLE
STONE (POLISHED)**



**MIXED PEBBLE
STONE (POLISHED)**



**WHITE PEBBLE
STONE (POLISHED)**





Supply & Installation of Granite & Slate Stone Fountains

AL SULAITEEN GARDENS can supply readymade granite and slate stone modern water fountain in all types of designs and finish to make your garden more attractive. Whether indoor or outdoor, please visit our show room on Mushireb-Doha.



DIMENSION
D.90 H. 180cm

06C-23A



FT-305B

DIMENSION
D. 65cm H.83cm



FT-306

DIMENSION
D. 65cm H.95cm



FT - 207

DIMENSION
82 x 82 x 27cm



FT - 207S

DIMENSION
82 x 82 x 27cm



FT - 234-3

DIMENSION
 Panel 1 x H.180cm Panel 1 x H.150 cm
 Panel 1 x H.120cm Basin 210 x 45 x 30cm



FT - 234-4

DIMENSION

Panel 4 x H.180cm

Basin 270 x 45 x 30cm



FT - 305

DIMENSION
DIAMETER 65cm



FT - 262

DIMENSION
90 x 90 x 76cm



FT - 337

DIMENSION
60 x 60 x 105cm



FT - 437S

DIMENSION
70 x 70 x 160cm



FT - 150

DIMENSION
70 x 60 x 118cm



FT - 251

DIMENSION
70 x 70 x 100cm



FT - 276

DIMENSION
50 x 50 x 110cm



FT - 477

DIMENSION
D.50 x H.100/125/150cm



FT - 332BS

DIMENSION
80 x 42 x 150cm



FT - 480S

DIMENSION
80 x 42 x 150cm



FT - 344-1

DIMENSION
100 x 75 x 150cm



FT - 234-1

DIMENSION
85 x 45 x 180cm



FT - 234-2

DIMENSION
80 x 45 x 180cm



FT - 93

DIMENSION
90 x 30 x 180cm



FT - 472AS

DIMENSION
120 x 60 x 180cm



FT - 382S

DIMENSION
120 x 60 x 160cm



FT - 472S

DIMENSION
120 x 60 x 160cm



FT - 254

DIMENSION
80 x 80 x 30cm



FT - 254S

DIMENSION
80 x 80 x 30cm



FT - 486

DIMENSION
170 x 60 x 150cm



LETTERS FOUNTAIN





FT - 347S

DIMENSION
120 x 70 x 150cm



FT - 380S

DIMENSION
75 x 42 x 120cm



FT - 347

DIMENSION
120 x 70 x 150cm



FT - 133

DIMENSION
60 x 60 x 110cm



08C-07

DIMENSION
Height: 100cm



FT - 50

DIMENSION
60 x 30 x 120cm



FT - 50A

DIMENSION
70 x 50 x 95cm



FT - 97

DIMENSION
45 x 45 x 75cm



FT-206

DIMENSION
60 x 35 x 78cm



FT - 128

DIMENSION
70 x 54 x 80cm



FT - 129

DIMENSION
50 x 50 x 90cm



FT - 222

DIMENSION
50 x 50 x 90cm



FT - 202

DIMENSION
92 x 55 x 78cm



FT - 231

DIMENSION
63 x 63 x 48cm



FT-343



FT - 238

DIMENSION
80 x 80 x 35cm



FT - 344

DIMENSION
100 x 70 x 100cm



FT - 240

DIMENSION
80 x 80 x 72cm

Ceramic Fountain



**Ceramic Fountain
Brown**

Height: 115cm



**Ceramic Fountain
White**

Height: 115cm



Our Nursery

AL SULAITEEN Agricultural Farm, located in Umm Salal Ali, occupies an area of 40 hectares and is designed in a scientific way to include all agricultural activities utilizing the latest technologies of production. A well established and maintained nursery, grooming rooms, single and multi-plan cooled greenhouses with an area of 12,00m², shade net houses and our research & development department. Our engineers are constantly looking for new ideas and developments around the world in the agricultural industry. Their job is to spot ideas that might have the potential to work in Qatar's climate and to find out if they can be applied locally to increase production or reduce costs and natural resources required.









Quality & Time Policy Objective

Al Sulaiteen Gardens aims to achieve customer satisfaction by striving to complete all projects as per the agreed program to the highest possible standards while meeting all necessary contractual requirements within agreed time.

The Management believes that the successful Implementation of Quality Management System and time fact is the key for achieving the above objectives.

All personnel in the organization are directed to contribute to the Enhancement of customer satisfaction through the implementation of the company Project Quality Plan.

The Management is committed to comply with the requirements of this standard and continually develop and improve its effectiveness.





Safety First Policy & Priorities



AL SULAITEEN GARDENS have a commitment to job site safety, and we believe that worker protection is an important element in the company's success and is a trust between **AL SULAITEEN GARDENS**, employees and the clients. Our excellent safety procedure demonstrates our dedication to the highest level of job site safety and quality assurance.

The comprehensive safety procedures implemented by **AL SULAITEEN GARDENS** are designed to meet the specific

requirements for the installation. We fully adopt the Health and Safety regulations and standards (2nd edition 2003) as laid out by the Ports Customs Free Zone Corporation (PCFC), and instruct, inform and guide all individuals of the general systems that are needed in the workplace to protect employees from potential risks / hazards that may cause any form of harm.

To ensure that working conditions are acceptable and to in still AWARENESS – of potential risks and hazards, as well as safety standards and safe working procedures to prevent any possible incidents.

Introduction to our Program

AL SULAITEEN GARDENS policy makes the safety and health of our employees the first consideration in the operation of our business. It is the intent of **AL SULAITEEN GARDENS** to comply with all the laws concerning the operation of the business and the health and safety of our employees and the public. To work within ethic Corporate Governance and consideration of all those around us.

We strive to be aware of the conditions in all work arenas that can produce or lead to injuries. No employee is required to work at a job known to be unsafe or dangerous to their health. Cooperation in detecting hazards, reporting dangerous conditions and controlling workplace hazards is a condition of employment. Employees are taught to inform their supervisor immediately of any situation beyond their ability or authority to correct. Employees will not be disciplined or suffer any retaliation for reporting a safety violation in good faith.



Safety First Priority

The personal safety and health of each employee of **AL SULAITEEN GARDENS** is of primary importance. Presentation of occupationally induced injuries and illnesses is of such significance that it will be given precedence over operation productivity. To the highest degree possible, management will be providing all mechanical and physical protection required for personal safety and health.

Employees are continuously made aware of the importance of safety in the work environment

Individual Cooperation Necessary

AL SULAITEEN GARDENS maintains a health program conforming to the best practices in our field.

Safety Program Goals

The objective of **AL SULAITEEN GARDENS** is a safe and healthy environment that will reduce the number of injuries and illnesses to an absolute minimum.

Safety Policy Statement

It is equally the duty of each employee to accept and follow established safety regulations and procedures.

Every effort will be made to provide adequate training to employees. However, if an employee is ever in doubt about how to do a task safely, it is their duty to ask a qualified person for assistance. Employees are expected to assist management in accident presentation.

Every injury that occurs on the job must be reported to management and / or the Responsible Safety Officer as soon as possible. An end of the day clear-up should be part of the working routine.

All rubbish, especially consumable materials such as packaging waste should be cleared daily to safe external storage.



SITE SAFETY REQUIREMENTS

All the employees and visitors must attend site safety induction before entering the site for the first time.

- All operatives are enforced to wear proper personal protective equipment (PPE) shall be well informed about the risk.
- All plant equipment must be in good working condition and inspected prior to use on site.
- All plant and equipment shall be operated by trained operations only.
- Banks men are to control the movement of the plants at site.

- When handling and spreading fertilizer / compost workers should wear gloves, safety shoes or any other Personal Protective Equipment (PPE).
- Eating, drinking or smoking while handling fertilizer / compost is not allowed.



HAZARDOUS CHEMICAL STORE

All hazardous chemicals such as pesticides, fungicides and herbicides must be kept in a separate storeroom which can be locked and is constructed in such a manner as to be isolated from other rooms via roof space or ventilation points. Exposure to volatile gasses released from open containers is potentially very dangerous. Ideally, it should be possible to purge the air in the store rooms prior to entry.

The chemical inventory must be controlled by a designated person. Hazardous data sheets must be readily available. Persons using chemical must be adequately trained to work to laid down safe working procedures.

SAFE SYSTEMS OF WORK AND SIGNAGE

Signs should indicate hazardous substances on the site.

Only individuals with a **Pest Control Officer Certificate (PCO)**, are to mix any chemicals / fertilizers or pesticides. Any individuals spraying these harmful substances must be provided with the relevant safety clothing.

All appropriate steps should be taken with the aim of ensuring that the workplace procedures and processes do not pose any foreseeable risk to the health and safety of employees. Where reasonably practicable, hazards should be removed by altering the procedures and process, but if this cannot be achieved, operating procedures should be reviewed.

Storage of finished products, packages and raw materials should be in conformity with good housekeeping principles and practices. Blending and filling operations should be performed in conformity with defined safety operating procedures.

Maintenance activities, by their nature, involve a wide variety of hazards, many of which are well recognized and may be subject to legislative controls. The company requires the demonstration of competence by those engaged in certain work activities.

FIRST AID KIT

Every site must have a proper equipped first aid kit. Where there are more than fifty (50) employees, a first aider is appointed or assurance that there is adequate first aid assistance on the site.

A designated person is responsible for the FIRST AID box.
Signs are affixed to show where the first aid boxes are.

PLANNING

The company formulates plan to fulfil its safety and health policy as set out in the Safety Statement. An effective management structure and arrangements should be put in place for delivering the policy. Safety and health objectives and targets should be set for all managers and employees.



Documents & Classifications

STATE OF QATAR
MINISTRY OF INTERIOR
General Directorate of Passport



دولة قطر
وزارة الداخلية
الادارة العامة للجوازات

بطاقة قيد المنشأة Establishment Card

Est. ID 13-7271-01 رقم قيد المنشأة

اسم المنشأة : شركة السليطين للحدائق

Est. Name : ALSULAITEEN GARDENS

Sector : COMMERCIAL

القطاع : تجاري

First Issue : 2014-03-20 تاريخ اول اصدار :

Expiry Date : 2022-03-10 تاريخ الصلاحية :

مدير عام الادارة العامة للجوازات



* 1 3 7 2 7 1 0 1 *

2021/03/21 24/072

Authorizers		المفوضين
التوقيع	الاسم	رقم الوثيقة
	عبدالله سالم سعد السليطين ABDULLA AL-SULAITIN	24763400122
	منصور عبدالله سالم سعد السليطين MANSOOR AL-SULAITIN	28063402977
	فهد عبدالله سالم سعد السليطين FAHAD AL-SELAITIN	27663402455
	خالد عبدالله سالم سعد السليطين KHALID AL-SULAITEEN	27363400203

Cards 1 / 1 عدد البطاقات Instruction تعليمات

• على من يجد هذه البطاقة ان يقوم بتسليمها الى اي مركز للشرطة
• Whoever finds this card should deliver it to any police station.



وزارة التجارة والصناعة
Ministry of Commerce and Industry

Registration and Commercial
Licenses Department

إدارة التسجيل
والتراخيص التجارية

مستخرج بعض بيانات السجل التجاري

تاريخ الطباعة: 2021/09/12



رقم التسجيل التجاري: 98742
الاسم التجاري: شركة السليطين للخدمات
تاريخ إنشاء السجل: 16/05/2017
الشكل القانوني: شركة ذات مسئولية محدودة
حالة السجل: نشط
عدد الفروع: 0

رقم التسجيل الضريبي: 5000142893
الصفة التجارية: السمة التجارية
تاريخ انتهاء السجل: 15/05/2022
رأس المال: 3000000
جنسية المنشأة: قطر

معلومات الاتصال

أرقام الاتصال: +97433208721
صندوق البريد: 8588

الشركاء

الاسم	رقم الإثبات	رقم السجل	الجنسية	النسبة	الحالة
عبدالله سالم سعد السليطين	24763400122		قطر	1	نشط
مجموعة شركات السليطين		51661	قطر	99	نشط

المدراء (المثولون بالتوقيع)

الاسم	رقم إثبات	رقم السجل	الجنسية	الصفة (المناصب)
خالد عبدالله سالم سعد السليطين	27363400203		قطر	مدير (مناصب كاملة ومطلقة)
عبدالله سالم سعد السليطين	24763400122		قطر	مدير (مناصب كاملة ومطلقة)

Page 1 of 2

رقم السجل: 98742



تشهد غرفة تجارة وصناعة قطر بان المنشأة المذكورة اعلاه سجلت لدينا

Qatar Chamber certifies that the above mentioned establishment has been registered



وزارة التجارة والصناعة
Ministry of Commerce and Industry

Registration and Commercial
Licenses Department

إدارة التسجيل
والتراخيص التجارية

مستخرج بعض بيانات السجل التجاري

مدير (ملاحظات كاملة ومطلقة)	قطر	27663402455	محمد عبدالله سالم سعد السليطين
-----------------------------	-----	-------------	--------------------------------

الأنشطة التجارية

اسم النشاط	الرقم
رعاية وصيانة صانطر المصابيح والحدائق المنزلية وحدائق الأسقف و وحدات المصابيح الخاصة وغيرها	8130120

اسم النشاط	الرقم
التجارة في أثاث الحدائق	4759104
رعاية وصيانة أمتارها وحدائق الحدائق للأغراض السكنية	8130110

Page 2 of 2

رقم السجل : 98742



تشهد غرفة تجارة وصناعة قطر بان المنشأة المذكورة اعلاه سجلت لدينا

Qatar Chamber certifies that the above mentioned establishment has been registered



28/07/2020

ضريبة
Dhareeba
tax portal



TAX CARD - بطاقة ضريبية

The General Tax Authority of Qatar certifies that the entity is registered as per the following details:

تشهد الهيئة العامة للضرائب في دولة قطر أن الجهة أدناه مسجلة حسب البيانات التالية:

TIN Number	5000142893	رقم التعريف الضريبي
Taxpayer Name:	شركة السليطين للحدايق SALLAITIN GARDENS COMPANY	إسم المكلف:
Commercial Registration Number	98742	رقم السجل التجاري القطري
Address [Headquarter]:	Zone: 13 المنطقة Building: العيني Street: شارع العباس Qatar - قطر	العنوان (المركز الرئيسي):
Main Activity:	4759104 التجارة في اثاث الحدايق - 4759104-Trading in Wood Products	النشاط الرئيسي:
Legal Form:	شركة ذات مسؤولية محدودة Limited Liability Company	الشكل القانوني:
Activity Commencement Date:	12/03/2014	تاريخ بدء النشاط:
Number of Branches:	0	عدد الفروع:
Registered taxes :		الضرائب المسجلة :
Income Tax	REGISTERED - 12/03/2014 - مسجل	الضريبة على الدخل

الهيئة العامة للضرائب
GENERAL TAX AUTHORITY



هذه الوثيقة مستخرجة من النظام الآلي و ليس من الضروري التوقيع عليها

.This is a system generated document and does not require to be signed

2021/03/18
No 1 of 1

تاريخ الطباعة:
صفحة رقم:



Registration and Commercial
Licenses Department

وزارة الاقتصاد والتجارة
Ministry of Economy and Commerce

إدارة التسجيل
والتراخيص التجارية

رخصة تجارية



رقم الرخصة: 98014
الأسم التجاري: شركة السليطين للخدمات
نوع المنشأة التجارية: شركة
السمة التجارية: شركة

تاريخ اصدار الرخصة: 2014/03/12
تاريخ انتهاء الرخصة: 2022/03/10
رقم السجل التجاري: 98742

بيانات المدير المسؤول :

اسم المدير المسؤول: عبدالله سالم سعد السليطين
رقم الإثبات: 24763400122

جنسية المدير المسؤول: قطر
نموذج ختم المنشأة التجارية :

بيانات الموقع :

تصنيف الموقع: تجاري
نوع الموقع: مكتب تجاري
المنطقة: 13
الشارع: العباس
رقم الشارع: 802

عقار رقم: 9
رقم الدور/ الوحدة: 9
اسم مالك العقار: الشيخ خالد بن حمد بن عبدالله ال ثاني
وصف العنوان: بلدية الدوحة / مشيرب

الأنشطة التجارية :

إسم النشاط	الرقم
رعاية وصيانة مناظر المباني والحدائق المنزلية وحدائق الاسقف و واجهات المباني الخاصة وغيرها	8130120

إسم النشاط	الرقم
التجارة في اثاث الحدائق	4759104
رعاية و صيانة المتنزهات والحدائق لاغراض الاسكان العام	8130110



مدير إدارة التسجيل والتراخيص التجارية



Bldg. 23, Zone 13, Street 802 Musheireb
Doha, Qatar | P. O. Box 8858
Tel: +974 4029 2088 | Fax: +974 4032 0132
Mobile: +974 6661 6154 | +974 5583 1570
E-mail: info@alsulaiteengardens.com
Website: www.alsulaiteengardens.com

